

ETH0

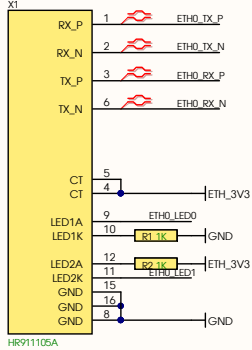

10/100 Mb Ethernet

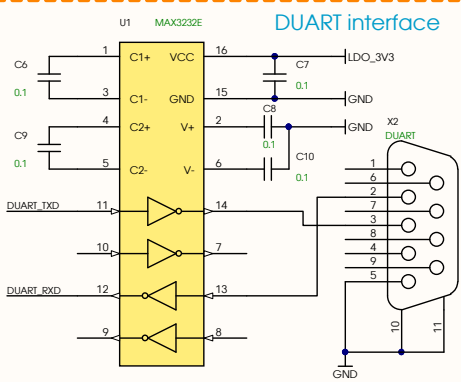

DUART interface

I2C0 Pull-Up

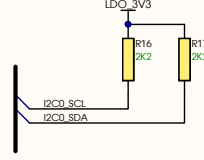

EV-IMX287-NANO Module

0	0	GND
1	2	GND
3	4	SSPO_CLK
5	6	SSPO_CMD
7	8	SSPO_DATA0
9	10	SSPO_DATA1
11	12	SSPO_DATA2
13	14	SSPO_DATA3
15	14	SSPO_DETECT
17	18	GPIO4_20
19	20	GPIO3_20
21	22	GPIO3_21
23	24	GPIO3_26
25	26	GPIO1_26
27	28	UART2_RXD
29	30	UART2_TXD
31	32	UART3_RXD
33	34	UART3_TXD
35	36	UART4_RXD
37	38	UART4_TXD
39	40	I2C0_SCL
41	42	I2C0_SDA
43	44	GPIO2_21 CAN_RX1
45	46	GPIO2_20 CAN_RX1
47	48	GPIO3_3 CAN_TX0
49	50	GPIO3_2 CAN_RX0
51	52	5V

При установке процессоров IMX287/285 на разъем могут быть выведены сигналы интерфейсов CAN0/CAN1.
CAN signals available only with IMX285/287 CPU

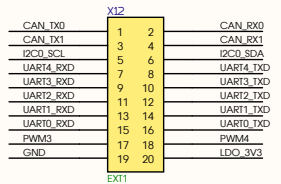

EXT interfaces

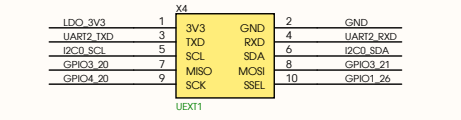

UEXT interfaces

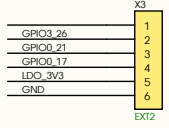

UEXT2

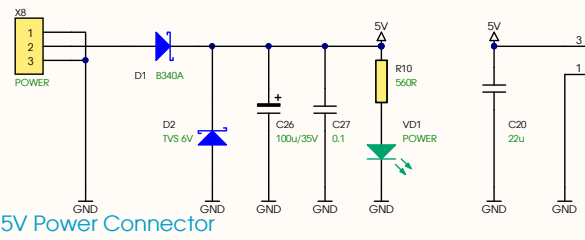

5V Power Connector

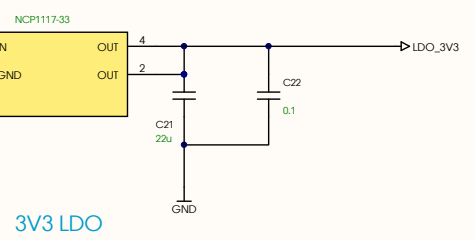

3V3 LDO

USB0 Host/Device

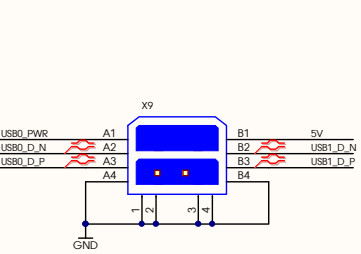

microSD card connector

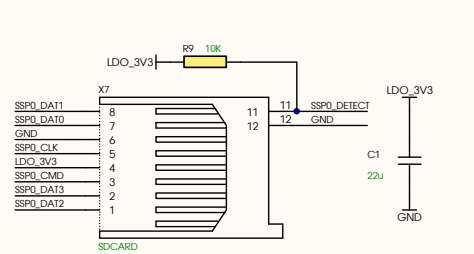

Reset Button

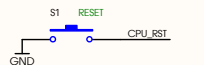

EV-IMX280NANO-X-MB
www.evodbg.com

