

### ETH0

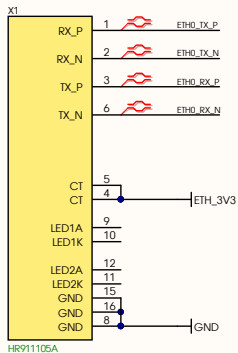

10/100 Mb Ethernet

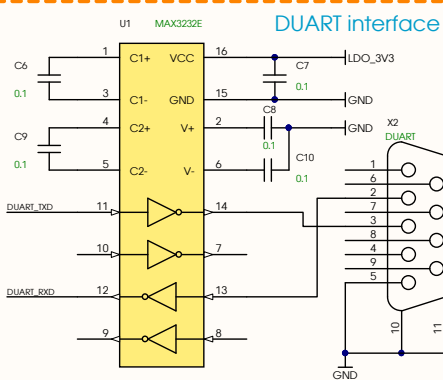

### DUART interface

### I2C0 Pull-Up

### EV-IMX287-NANO Module

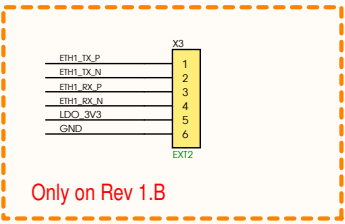
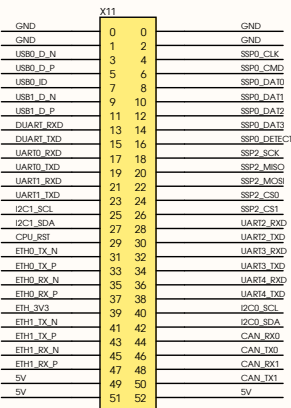

Only on Rev 1.B

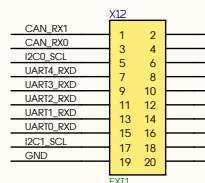

EXT interfaces

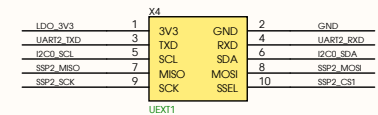

### UEXT interfaces

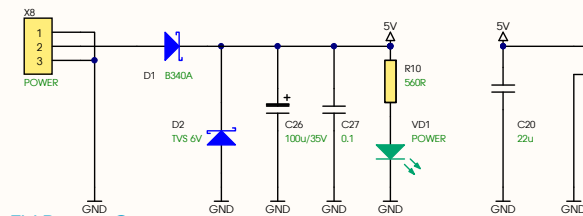
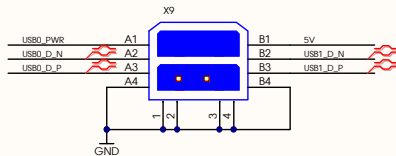

5V Power Connector

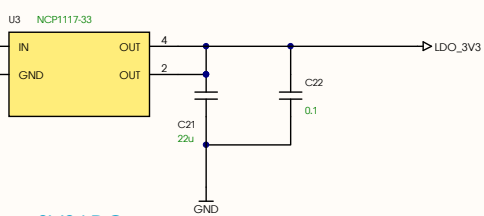

3V3 LDO

### USB0 Host/Device

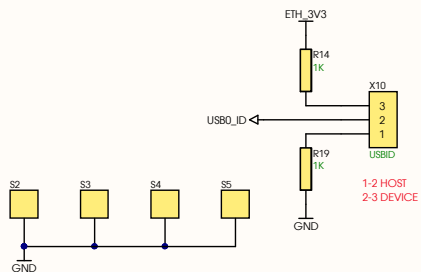

### microSD card connector

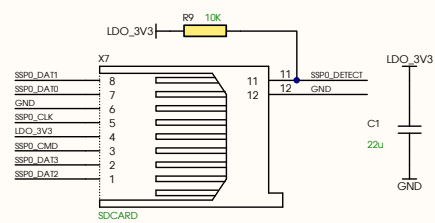

Reset Button

EV-IMX287NANO-X-MB  
www.evodbg.com